



**MCEN-15K-001**

*Please read the User Manual carefully before use and follow all operating and safety instructions*



**user manual**

english, español



MCEN – 15K – 001

## **Preface**

Thank you for purchasing our product. Users should read this manual carefully, follow the instructions and procedures, and beware of all the preventive measures when using this instrument.

## **Service**

If help is needed, you can always contact your dealer or Labbox via [www.labbox.com](http://www.labbox.com)

Please, provide the customer service representative with the following information:

- Serial number
- Description of the problem
- Your contact information

## **Warranty**

This instrument is guaranteed to be free from defects in materials and workmanship under normal use and service, for a period of 12 months from the date of invoice. The warranty is extended only to the original purchaser. It shall not apply to any product or parts that have been damaged due to improper installation, improper connections, misuse, accident or abnormal conditions of operation.

For claim under the warranty, please contact your supplier.



## **Safety Reminder**

### Common safety precautions

Carefully read the following safety precautions for a thorough understanding.

- Follow the instructions and procedures described in this manual to operate this centrifuge safely.
- Carefully read all safety messages in this manual and the safety instructions on the instrument.
- Safety messages are labeled as indicated below. They are in combination with signal words of “WARNING” and “CAUTION” with the safety alert symbol  to call your attention to items or operations that could be dangerous to you or other persons using this instrument. The definitions of signal words are as follows:

#### **WARNING** : Personal Danger

Warning notes indicate any condition or practice, which if not strictly observed, could result in personal injury or possible death.

#### **CAUTION** : Possible damage to instrument

Caution notes indicate any condition or practice, which if not strictly observed or remedied, could result in damage or destruction of the instrument.

**NOTE** : Notes indicate an area or subject of special merit, emphasizing either the product’s capability or common errors in operation or maintenance.

- Do not operate this centrifuge in any manner not described in this User manual. When in doubt or have any troubles with this centrifuge, ASK FOR HELP.
- The precautions described in this User manual are carefully developed in an attempt to cover all the possible risks. However, it is also important that you are alert for unexpected incidents. Be carefully operating this centrifuge.



## WARNING :

- This centrifuge is not explosion-proof. Never use explosive or flammable samples.
- Do not install the centrifuge in or near places where inflammable gases are generated or chemicals are stored.
- Do not place dangerous material within 30cm around the centrifuge.
- Make sure to prepare necessary safety measures before using samples that are toxic, radioactive or contaminated with pathogenic micro-organisms at your own responsibility.
- If the instrument, rotor and/or accessories that has been contaminated by solutions with toxic, radioactive or pathogenic materials, clean it according to the decontamination procedure that you are specified.
- If you require services at site, please sterilize and decontaminate it in advance, and then notice the service center involved in the details of the particular materials.
- Do not handle the power cord or turn on or off the POWER switch with wet hands to void electrical shocks.
- For safety purposes, do not enter within 30cm around this centrifuge while it is in operation.
- While the rotor is rotating, never forcedly release the door lock.
- Unauthorized repairs, disassembly, and other services to the centrifuge except by our service center are strictly prohibited.



## CAUTION

- This centrifuge must be located on one firm and level table.
- Make sure the centrifuge is horizontal before running.
- Make sure the angle between the door and cover is greater than 70 degrees when open the door.
- Be careful not put your fingers or hands between the door and cover when the door off.
- Do not move or relocate this centrifuge while it is running.
- When there is fluid in the rotor chamber, please promptly dry with a dry cloth to avoid sample contamination.
- Ensure to remove any objects and fragments of the tubes dropped inside the rotor chamber before running this centrifuge.
- Cautions on rotors
  - 1) Always check for corrosion and damages on the rotor surface before using it. Do not use the rotor if such abnormality found.
  - 2) Do not set the centrifuge speed override the allowable minimum speed of the rotor kits (rotor or the other adapters). Make sure to run it below the allowable minimum speed.
  - 3) Do not exceed the allowable imbalance.
  - 4) Use the rotor and tubes within their actual capacities.
  - 5) If the rotor is provided with a lid, ensure it is tightened before the operation.
- If any abnormal condition occurs during operation, please stop it immediately and contact our service center. Notice the service the alarm code if displayed.
- Earthquake damage is likely to the centrifuge, contact our service center if abnormality observed.

## 1. Specifications

Maximum speed	15000rpm, increment: 100rpm
Maximum RCF	15100×g, increment: 100×g
Maximum capacity	2ml×12
Timer	30 seconds -99 minutes-HOLD, continuous operation

Driving Motor	Brushless DC motor
Safety devices	Door interlock、 over-speed detector、 over-temperature detector、 automatic internal diagnosis
Power requirements	Single-phase, 110V-240V, 50Hz/60Hz, 3A
Dimensions (mm)	(L) 255× (W) 245× (H) 140
Weight	6kgs
Additional features	Speed/RCF switch、 Pulse operation、 Processing display、 Voice reminder

## 2. Declaration of Conformity

<b>Construction in accordance with the following safety standards:</b>
EN 61010-1 EN 61010-2-10
<b>Construction in accordance with the following EMC standards:</b>
EN 61326-1/ FCC Part 15 Subpart B/ IEC 61010-1
<b>Associated EU guidelines:</b>
EMC-guidelines: 2004/108/EC Instrument guidelines: 2006/95/EC
This ISM device complies with Canadian ICES-001. Cet appareil ISM est conforme à la norme NMB-001 du Canada.

## 3. Required Operational Condition

### 3.1 Basic operational Conditions

- (1) Power: 110V-240V, 50Hz/60Hz, 3A.
- (2) Ambient temperature: 2°C-40°C.
- (3) Relative humidity: ≤80%.
- (4) No vibration and airflow around.
- (5) No electric dust, explosive and corrosive gases around.

### 3.2 Transport and storage condition

- (1) Storage temperature: -40°C-55°C.
- (2) Relative humidity: ≤93%.

## 4. Installation

This section describes the instructions that you should abide when install the centrifuge to ensure your safety and the optimum performance. Before moving the centrifuge, the rotor must be removed.

### WARNING :

- Incorrect power supply may damage centrifuge.
- Make sure the power source conforms to the required power supply before connecting.

### 4.1 Location

- (1) Locate this centrifuge on a firm, flat and level table, ensure the four feet of this centrifuge stand on the table firmly. Avoid installing on the slippery table-board that conveys vibration.
- (2) Ideal ambient temperature is  $20^{\circ}\text{C} \pm 5^{\circ}\text{C}$ , avoid placing the centrifuge in direct sunlight if temperature exceeds  $30^{\circ}\text{C}$ .
- (3) Keep clearances of at least 10cm on both sides of centrifuge and at least 30cm behind it to ensure its cooling efficiency.
- (4) No heat or water resource nearby, otherwise easily cause sample temperature increase or centrifuge failures.

### 4.2 Connection of the power cord and grounding

#### WARNING:

- Do not touch the power cord with wet hands to avoid electrical shocks.
- This centrifuge must be grounded properly.

- (1) This centrifuge is equipped with a 3P flat plug; grounding can be done just by plugging the 3P plug into the outlet.
- (2) A cover 10A outlet which has a good ground is required, and meet with local safety requirements.

## 5. Parts

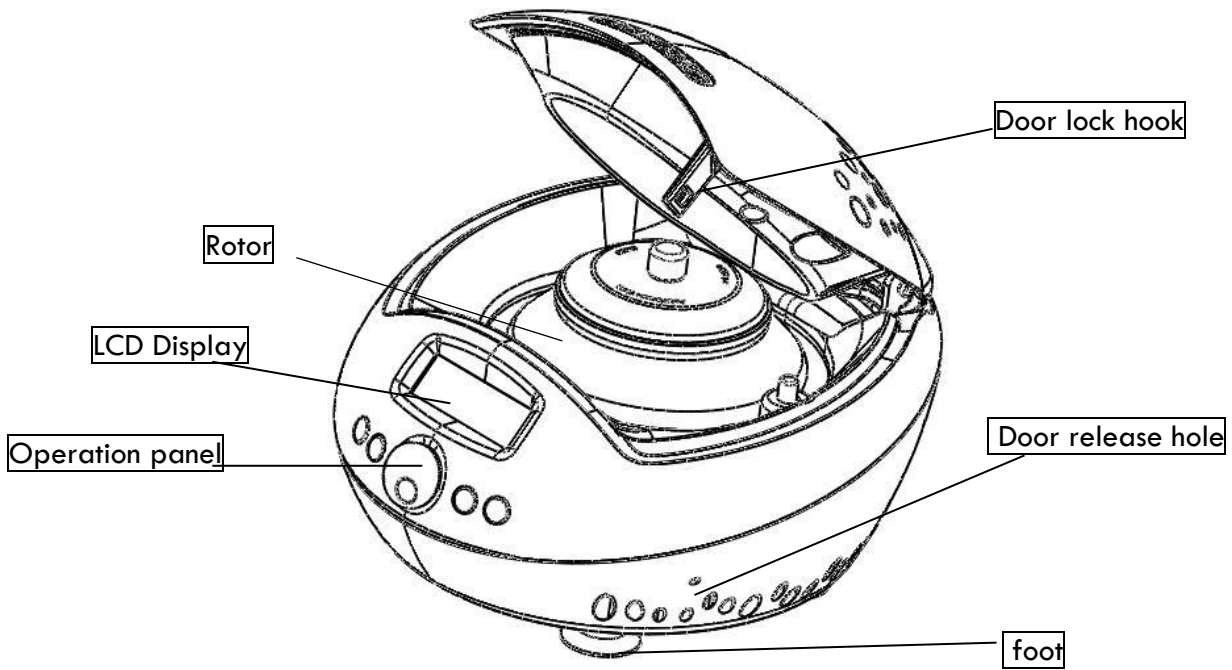

Figure 5.1 MC15K front view of centrifuge

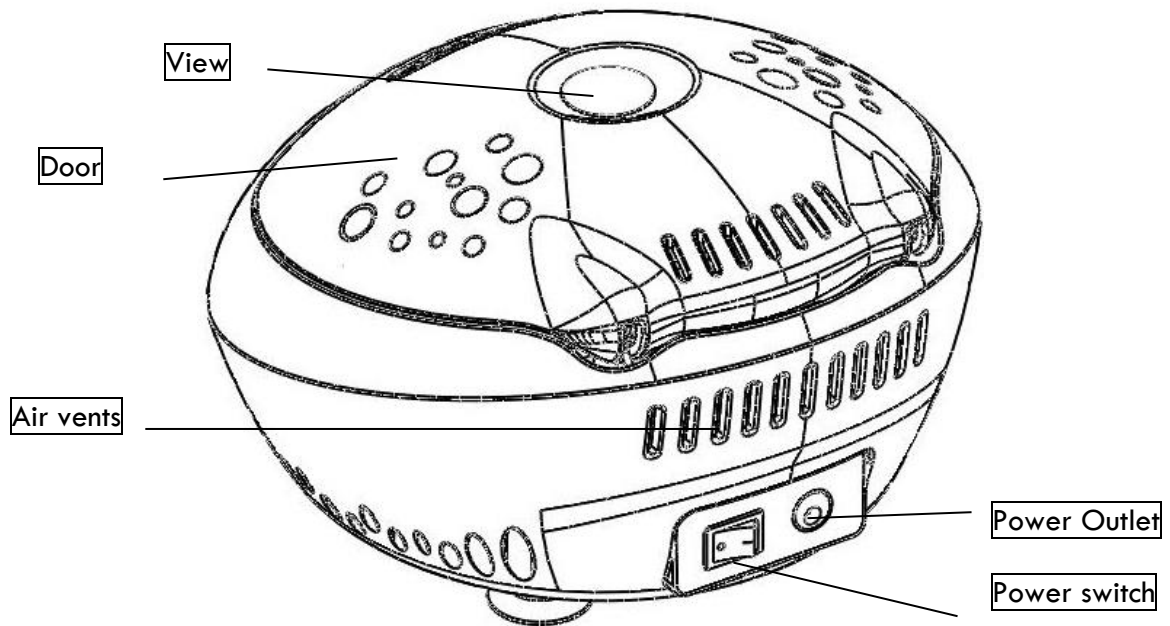

Figure 5.2 MC15K Rear view of centrifuge



## 6. Operation panel

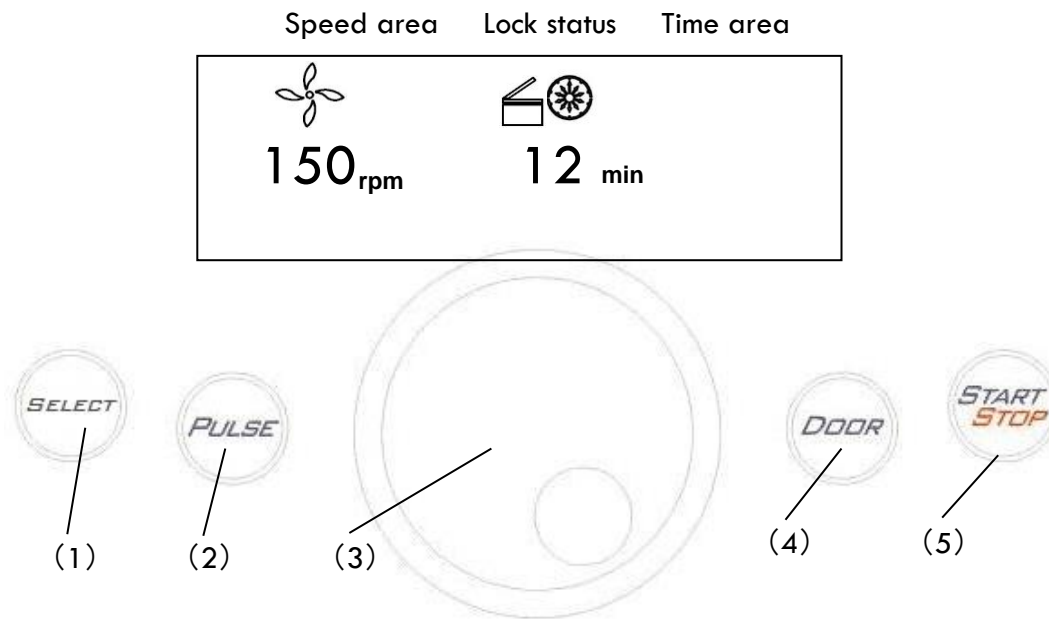







Figure 6-1 Operation Panel

Item	Symbol	Name	Function
1		Select button	Press the button to choose the parameter which you want to modify.
2		Pulse button	When the door closed, press and hold the button to accelerate running, release the button to stop it.
3		Parameter button	Clockwise rotate to increase parameter values. counter-clockwise rotate to decrease parameter values. Press down the button, shift between speed and RCF display.
4		Open/ lock button	Press the button to open the door The button is not available when the centrifuge is running.
5		Start/ Stop button	Press down the button to start running. The centrifuge will brake to stop running if press the button during centrifugation.

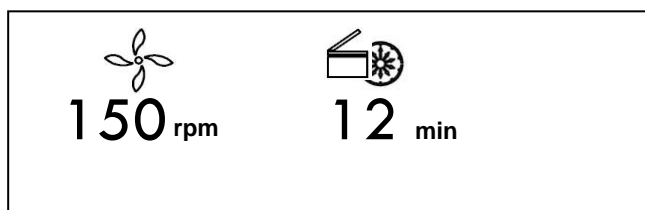





Figure 6-2 the main interface

The main interface as figure 6-2. At this point speed was set to be 15000rpm, the running time was 12 minutes. When speed symbol  is rotating, indicating the centrifuge is running. Time display symbol  display the rate of working to time setting. The total time setting is divided into 10 scales.

## 7. Rotor Preparation

### 7.1 Prepare the sample

### 7.2 Inject the sample into tubes.

 CAUTION : Excessive sample may cause leakage in the centrifuge tube, keep the actual capacity.

- Do not exceed the actual capacity specified in the instruction manual.

### 7.3 Keep the tubes balance

- See Table 7.1 for allowable imbalance of each rotor.
- Although this centrifuge can accept sample balancing by eye, we recommend that you use this centrifuge in a well-balanced condition to prolong its life expectancy.
- Never intentionally run the centrifuge under unbalanced condition even though the allowable imbalance is not exceeded.

### 7.4 Inspect the rotor

 CAUTION :

- Any abnormality such as corrosion or scratches are found, stop using the rotor and contact our service center.
- Only manufacturer's rotors which claimed can be used with the unit are allowed.

## 7.5 Symmetrically load centrifuge tubes in rotor

### ⚠ CAUTION:

- Make sure the rotor door is securely fixed on the rotor, rotor and spindle are tightened. Otherwise, the rotor may be moved off while rotating and cause damage of the centrifuge or rotor.

## 8. Operation

### ⚠ CAUTION :

- Do not push or lean against the centrifuge while it is running.
- Do not run the centrifuge with fragments of tubes or dew drops left in the rotor chamber.
- If this centrifuge makes strange noise during its operation, stop it immediately and contact our service center. Notify the alarm code if displayed.

### 8.1 Normal Operation

Turn on the POWER switch, The centrifuge will display the running interface last time after passing the self-checking process. (See figure 8-1)

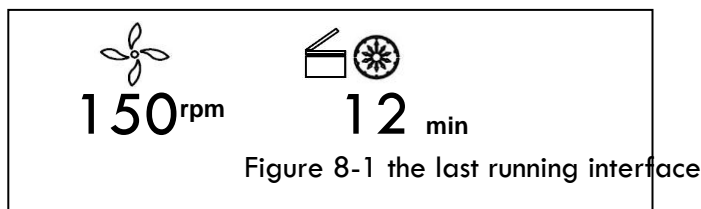

- Speed: 15000rpm. Running time: 12 minutes.
- The door lock is released.

#### 8.1.1 Rotor loading and removal

### ⚠ CAUTION :

- Load the rotor on the spindle to ensure rotor is in position until it contacts with the spindle, and tighten the screw to connect firmly the rotor with spindle, otherwise the rotor maybe move off to damage the centrifuge.
- Should be confirmed the door is firmly tightened with rotor.

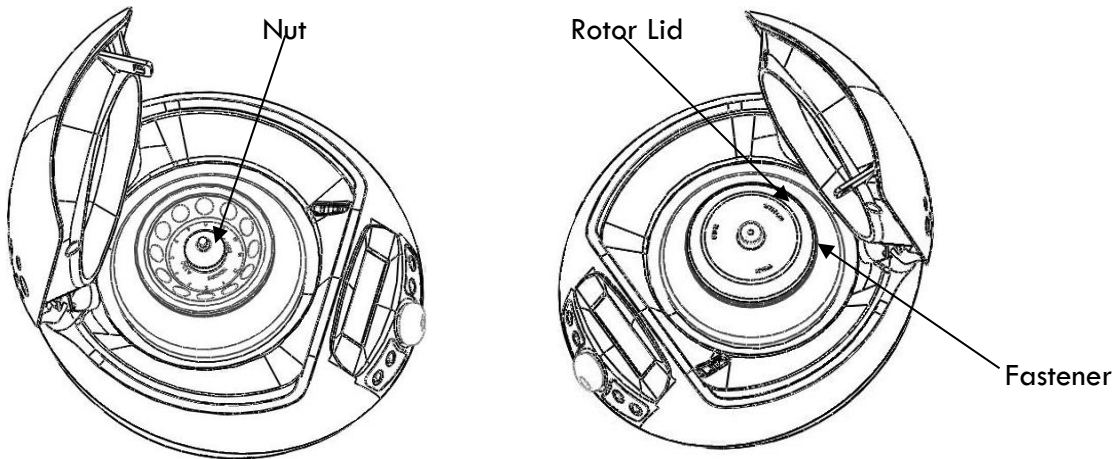





Figure 8-2 the rotor installation

- Load the rotor on the spindle to ensure rotor is in position until it fit well with the spindle.
- Rotate the rotor slightly by your fingers to double check, if the rotor vibrates obviously, load the rotor again.
- Hold on the rotor by one hand, tighten the nut clockwise by the other hand, and make sure tighten firmly.
- Put the rotor lid on the rotor, press the fastener down and make the fastener join with the rotor nut tightly.
- Close the door and start running.
- To release the rotor, first, pull the fastener up to remove the lid, and then, turn the rotor nut counterclockwise.







**⚠ CAUTION :**  
Check that the rotor is firmly tightened before each start.

### 8.1.2 Set the operation parameters



Press the  button to select required parameters. The parameter can be modified when the parameter is flashing. Clockwise rotate the parameter button  to increase parameter value; counter-clockwise rotate the parameter button  to decrease parameter value. Parameter button  rotate faster, parameter value increase faster. The minimum speed increment is 100 rpm, the minimum time increment is 1 second.

#### (1) Set the speed





- Press the select button , choose the speed unit rpm, showing the speed parameter.
- While select speed button, the speed symbol will flash into the speed parameter input status.
- The minimum speed value you can set 500rpm, the minimum increment is 100rpm.

- Clockwise rotate parameter button  to increase parameter value; counter-clockwise rotate parameter button  to decrease parameter value.
- You can quick set value by parameter button , quickly rotate parameter button  to speed up parameter changing.
- There is a circulating function to increase/decrease parameters. Clockwise rotate parameter button , values circulate from small → large → maximum → minimum; counter-clockwise rotate parameter button , values circulate from large → small → minimum → maximum.



(2) Set the time

- Press select button , time value flash into time setting mode.
- Rotate parameter button  to set running time range from 30 seconds to 99 minutes.
- When time displays as HD, that showing long-running mode.

### 8.1.3 Start the operation

- (1) Press running button  to start running
- It will start timing once the rotor starts running, the screen displays remaining run time.
- (2) Inquiry and modify the operation parameters
- Press select button , return to the preparation interface and displays setting parameters. Press again the select button , once the parameter symbol is flashing, rotate parameter button  to modify parameters. Release button after 5 seconds, centrifuge will return to normal operation mode and run process according to the new parameters.
  - After time parameter has been modified, the operation time is not cleared and will continue to be accumulated.
- (3) Alarm display
- If anything wrong in processing, the centrifuge will brake to stop automatically, and display the error code on the time area. You can find out the malfunction causes by checking the table 10-1, and make correct actions accordingly.

### 8.1.4 End the operation



- (1) The centrifuge will brake when it reaches the setting time or  button is pressed.
- When the rotor stops rotating, centrifuge will start beeping to alarm the operation was over.
- (2) Open the door
- The door can be released automatically when the operation was over.
  - After door closed, you are able to press the  button to open it.
  - After ending the operation, the program will store the setting parameters of this operation, and will recall these parameters when restart the program.

- (3) Open the door and take out the rotor and sample.

## 8.2 RCF Operation

- (1) Turn on the POWER switch.

- (2) Set a RCF value.

- Press the select button , choose speed unit  $\times g$ , the speed symbol will flash into RCF parameter input status.
- If no button is pressed after the speed parameter has flashed for 5 seconds, the inputting mode will be shut down.
- Rotate parameter button  to input a RCF value, RCF increment is  $100\times g$ .

- (3) Set operating conditions

The other operation, please refer to the section 8.1.

## 8.3 Pulse Operation

This function is used to remove the residual samples adhered on the interior of the tubes.



Note : The button works only when the rotor stopped and the door locked.

- (1) Turn

on the

POWER switch and load the rotor on the spindle, tighten the rotor door and make sure it is in secured position, and then close the door.

- (2) The centrifuge gets into preparation mode and displays last running parameters.

- (3) Press  knob and hold, speed up to reach the maximum speed. While release  knob during acceleration, the centrifuge will start to decelerate and stop.

## 9. Maintenance



Do not follow the recommended instructions for cleaning or disinfecting may damage the centrifuge.

- (1) Centrifuge

- If the centrifuge is exposed to ultraviolet rays for a long time, the color of the doors may be changed or the label may be came off. After using, cover the centrifuge with a piece of cloth to protect it from direct exposure.
- Once the centrifuge is heavily dirty, clean it with a cloth or sponge moistened with a neutral detergent solution.
- Sterilize the centrifuge by wiping with a cloth moistened with 70% ethanol solution.

## (2) Rotor chamber

 **CAUTION** : Do not directly pour water, neutral detergent or disinfectant solution into the rotor chamber. Otherwise fluids may leak into the drive units and cause corrosion or deterioration to the bearings.

- Once the rotor chamber is dirty, clean with cloth or sponge moistened with a neutral detergent solution. Sterilize the centrifuge by wiping with a cloth moistened with 70% ethanol solution.

## (3) Drive shaft

- Recommend have a regular maintenance for drive shaft. You can wipe the drive shaft with soft cloth, and then apply a thin coat of silicon grease to it.

## (4) Door

- Clean and sterilize the door using the same method as the step 1).

## (5) Rotor

- To prevent corrosion, remove the rotor from rotor chamber. If do not use for a lone term, then detach the rotor door and upside the rotor down to dry the tube holes.
- If a sample is leaked in the rotor, rinse the rotor with water. Apply a thin coat of silicon grease to the rotor when it is completely dried.
- The rotor should be regular maintenance, recommend to cleaning it each 3 months to ensure tube and rotor holes keep clean, and then apply a thin coat of silicon grease.

# 10. Troubleshooting

## 10.1 Frequent problems list

This centrifuge is designed with self-diagnosing function. When something is wrong and it is not available to operate, the alarm code will be displayed on the screen, and the operator can know the malfunction caused by the alarm code.

 **WARNING** : Do not open the door when the rotor is rotating during maintenance.



Symptom		Causes	Solutions
Nothing appears on the screen when the POWER is turned on.		<ul style="list-style-type: none"> <li>·Building power circuit breaker trips.</li> <li>·the fuse was blown out.</li> </ul>	<ul style="list-style-type: none"> <li>·Remove the trouble and turn on the POWER.</li> <li>·Replace the fuse.</li> </ul>
Abnormal vibration		<ul style="list-style-type: none"> <li>·Rotor do not match with spindle</li> <li>·Samples are imbalance</li> <li>·Rotor lid loosed</li> </ul>	<ul style="list-style-type: none"> <li>·Install again the rotor</li> <li>·Weighting scales, install symmetrically</li> <li>·Tighten the rotor lid firmly</li> </ul>
Alarm code appeared on the time display screen	E-02 Door fault	<ul style="list-style-type: none"> <li>·The door opened in running.</li> <li>·The  button is pressed while the door opening.</li> </ul>	<ul style="list-style-type: none"> <li>·Close the door immediately.</li> <li>·Close the door, and then start to operate.</li> </ul>
	E-06 Set wrong speed	<ul style="list-style-type: none"> <li>·The setting speed exceed the allowable range.</li> </ul>	<ul style="list-style-type: none"> <li>·Modify the speed value.</li> </ul>
	E-10~86	<ul style="list-style-type: none"> <li>·Read the service manual</li> </ul>	<ul style="list-style-type: none"> <li>·Contact with service center</li> </ul>

Table 10-1 Frequent problems and solutions

- Alarm code E-1 ~ 9 are related to wrong operating. You can continue running the centrifuge after the cause removed.

## 10.2 How to open the door

 **WARNING :**

- Never open the door while the centrifuge is running.
- The door is opened once rotor is still rotating, close the door immediately.

### 10.2.1 In the case of power on

 **CAUTION :** The door just can be opened while the power on and rotor stops rotating.

- (1) Turn on the POWER switch, the door lock will release automatically.
- (2) The door lock will release automatically once the operation finished.
- (3) While the rotor stops, press  button, door lock can be released to open the door.



## 10.2.2 In the case of power outage

If the door cannot be opened due to the power outage, open the door as the follows.

- (1) Make sure if the rotor is rotating.
  - Listen carefully to ensure that no rotating sound can be heard.
- (2) Insert a door key into the hole to open the door lock.
  - Identify the hole which is located on the top right side of the unit.
  - Insert a door key into the hole and push forward to release the door lock, and then open the door.

# 11. Instructions of rotor and tube

## ⚠ CAUTION :

- Read the instructions thoroughly, correct use rotor.
- Do not exceed the allowable maximum speed of rotor、 tube and adapters etc., be care that the allowable maximum speed of some adapters are lower than the rotor's.

## 11.1 The rotor instructions

### 11.1.1 Rotor structure

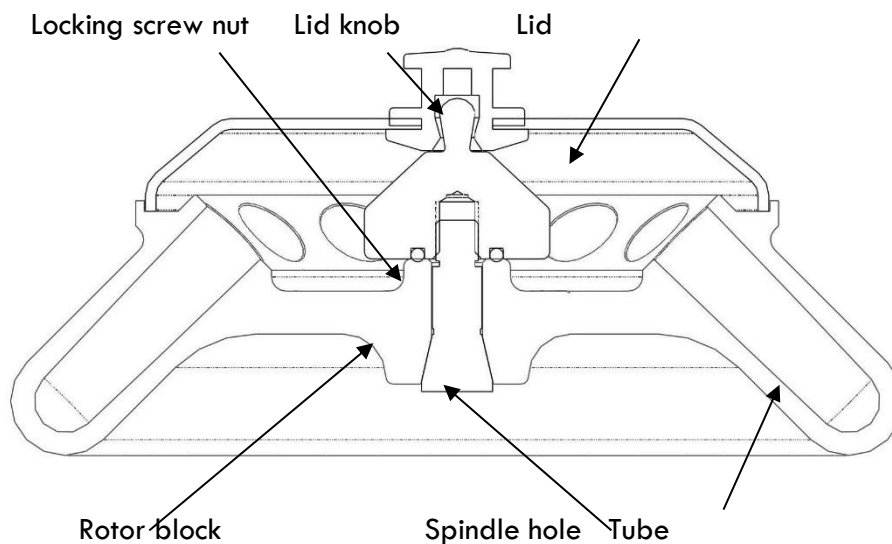

Figure11-1 the rotor profile

### 11.1.2 Available rotors and adapters

The rotor can be used as follows:

Table 11.1 Rotors and adapters

Rotor type	ID code	Tube/bottle	Adapter	Maximum speed (rpm)	Maximum RCF (×g)	Allowable imbalance(*)	
						imbalance	volume imbalance
MCEN-A05-001	01	1.5/2.0ml tube		15000	15100	2.0g/tube	5mm/tube
		0.2ml PCR tube	MCEN-A06-024	15000	15100		
		0.5ml microtube	MCEN-A07-024	15000	15100		

11.1.3 Notice

- The centrifuge rotor can separate sample which density lower than 2.0g/ml. if the separated samples density is over 2.0g/ml, please calculate allowable speed depending on the following formula.

$$\text{Allow Speed (rpm)} = \text{Maximum speed} \times (2.0(\text{g/ml}) / \text{Sample density (g/ml)})^{1/2}$$

11.1.4 Autoclaving

- The rotor makes by high-strength aluminum alloy material, can be high-pressure sterilization: 121°C (1.0kg/cm<sup>2</sup>) 20 minutes.

 **CAUTION:** The lid of the rotor is made of plastics, can not be high-pressure sterilization, only ordinary sterilization can be used.

11.2 Tubes

11.2.1 Cleaning and sterilizing tubes, please refer to the table below.

Table 11.2 Cleaning and sterilizing conditions for tubes

○ : Applicable X : Inapplicable

Condition		Material	PA	PC	PP
Cleaning	Cleaning fluids	Acidic (pH5 or lower)	X	X	X
		Acidic (higher than pH5 )	○	○	○
		Alkaline (higher than pH9 )	○	X	○
		Alkaline (pH9 or lower)	○	○	○
		Neutral (pH7)	○	○	○
		Warm water(up to 70°C)	○	○	○
	Ultrasonic cleaning	Neutral detergent (pH7)	○	○	○

Sterilization	Autoclaving	115°C (0.7kg/cm <sup>2</sup> ) 30minutes	○	○	○
		121°C (1.0kg/cm <sup>2</sup> ) 20 minutes	X	○	○
		126°C (1.4kg/cm <sup>2</sup> ) 15 minutes	X	X	X
	Boiling	15 to 30 minutes	○	○	○
	Ultraviolet sterilization	200-300nm	X	X	X
	Gas sterilization	Ethylene oxide	○	X	○
		Formaldehyde	○	○	○

PA: Polyallomer ; PC : Polycarbonate ; PP : Polypropylene

### 11.2.2 Cleaning PC tubes

PC materials are low in chemical resistance against alkaline solutions. Avoid using neutral detergents with pH higher than 9. Note that pH of some neutral detergents are still higher than 9 even if diluted according to the instruction in the maker's catalog. Use detergent with its pH between 7 and 9.

### 11.2.3 Autoclaving PA, PC and PP tubes

PA begins softening at about 120°C, PC and PP at about 130°C. Autoclave PA tubes at 115°C (0.7kg/cm<sup>2</sup>) for 30 minutes and PC and PP tubes at 121°C (0.1kg/cm<sup>2</sup>) for 20 minutes. If a certain temperature is exceeded, the tubes may be deformed.

When using a sterilizing chamber, please operate as follows:

- (1) Place tubes in vertical position, mouths upward. If tubes are placed sideways, they may deform into an oval shape due to gravity.
- (2) Remove screw nuts and inner covers to prevent from deformation or rupture.
- (3) Wait until the sterilizing chamber cools down to the room temperature before the tubes are removed.

### 11.2.4 Condition and life expectancy of tubes

The life expectancy of plastic tubes depends on the characteristics of samples, speed of the rotor used, and temperature applied, and so on. When the plastic tubes are used for centrifuge of ordinary aqueous samples (pH between 5 and 9), their life expectancies are defined as follows.

Be operated at the maximum speed:

High quality tubes (PA, PC, PP): 30-50 operations

Ordinary tubes (PA, PC, PP): around 10 operations (Using in low speed can extend the tube life) .

Life expectancy of tubes also depends on the pretreatment conditions such as cleaning and sterilization, lifetime can be cut down.

**Notice: Do not use cracked tubes.**

## 12. Calculation Relative Centrifuge Force (RCF)

An RCF can be determined as the calculation formula following.

Calculation formula:

$$\text{RCF} = 1.118 \times r \times n^2 \times 10^{-5}$$

r—rotating radius, unit: cm; n—rotating speed, unit: rpm

## 13. Guarantee

### 13.1 Guarantee of centrifuge

This centrifuge is guaranteed for two years from the date of delivery provided that it has been operated and maintained properly.

### 13.2 Guarantee of the rotor

The rotor is guaranteed for **5 years** from the date of delivery upon manufacture. Please pay attention, do not use the rotor once it has been corrosion or fatigue damage. We do not guarantee this centrifuge and the rotor under the following conditions even if within the guarantee period expires:

- (1) Failures caused by incorrect installation.
- (2) Failures caused by rough or improper handling.
- (3) Failures caused by conveyance or relocation after installation.
- (4) Failures caused by unauthorized disassembly or modification.
- (5) Failures caused by using parts of the other companies, such as rotors and adapters.
- (6) Failures caused by natural disasters including fire, earthquakes and so on.
- (7) Consumables and parts have a limited guarantee period

## After-sales Service

In order to ensure to operate centrifuge safely and efficiently, it is necessary for regular maintenance. If centrifuge has problems, do not attempt to repair it by yourself. Contact our sales or service center.